

Flare™

4KSDI CAMERAS



Video cameras with Global Shutter CMOS Sensors

APPLICATIONS

Aircraft and Vehicle Recording

Security and Surveillance

Medical Imaging

Specialty Video Production



FEATURES INCLUDE:

- Compact One-Piece Rugged Design
- Super 35mm Low-Noise Global Shutter Sensor
- Multiple Lens Mount Options (EF, F, PL-mount)
- 3G/HD-SDI Output Formats
- 10-bit 4:2:2, 4:4:4, or RAW Output
- Synchronize Multiple Cameras via Tri-Level Sync
- Adjustable Color Matrix, Saturation and Gamma
- Advanced Auto Exposure Control

SPECIFICATIONS

Camera Model	Flare 4KSDI
Output Modes	UHD or DCI 4K up to 60 fps
Optical Format	Super 35mm / APS-C (4K: 25.5mm diagonal, UHD: 24.2mm diagonal)
Sensor Type	CMOS w. global electronic shutter
Sensor Options	Color (Bayer) or Near IR enhanced monochrome
Dynamic Range	60 dB (10 stops)
Output Interface	Quad-Link HD-SDI, Dual-Link 3G-SDI or Quad-Link 3G-SDI
Output Format	10-bit 4:2:2(Y'Cb'Cr'), 4:4:4 (RGB) or RAW (Bayer)
Exposure Control	Automatic (AEC) or manually adjustable
Luma Control	Gamma, master pedestal, white clipping offset with adjustable knee function
Color Control	Color matrix, RGB offsets, saturation adjustment, Preset/Auto/Tracking White Balance
Synchronization	Tri-level sync input (BNC)
Camera Configuration	RS-485, use handheld remote for OSD or use PC software, cables up to 1000 ft
Mechanical/Electrical	
Dimensions	91.7 mm x 91.7 mm x 47.7 mm (not including lens mount)
Lens Mount	Active EF-mount, Passive EF-Mount, F-mount, PL-Mount
Camera Mounting Points	1x 3/8"-16, 7x 1/4"-20, 8x #M4x0.7
Weight	750g (not including lens mount)
Power Requirements	10W, 7-19V DC via Hirose 12-pin
Operating Temperature	-30°C to 45°C, 20-85% humidity (non-condensing)
Storage Temperature	-40°C to 85°C, 10-90% humidity (non-condensing)

OUTPUT MODES

Quad-Link HD-SDI or Dual-Link 3G-SDI:

UHD 10-bit 4:2:2/RAW: 23.98, 24, 25, 29.97, 30
 4K 10-bit 4:2:2/RAW: 23.98, 24, 25, 29.97, 30

Quad-Link 3G-SDI:

UHD 10-bit 4:2:2/RAW: 50, 59.94, 60
 UHD 10-bit 4:4:4: 23.98, 24, 25, 29.97, 30
 4K 10-bit 4:2:2/RAW: 47.95, 48, 50, 59.94, 60
 4K 10-bit 4:2:2/RAW: 23.98, 24, 25, 29.97, 30

ORDERING

Part Number	Sensor Type
4KSDI	Color
4KNSDI	Near IR Enhanced Monochrome

For 4KSDI (color) complete kit including accessories, use P/N 4KSDIKIT[xx]-[y] (xx = NA/EU/UK, y = P/E/A/F). Includes 4KSDI, FLARESDIRMT, ACPWRTAP[xx], CABFLAREBATT or CABFLAREBATT3 (Active EF), CABUSB4852M and lens mount [y] (P = PL, E = Passive EF, A = Active EF, F = F-mount)

MECHANICAL DIAGRAMS

Front

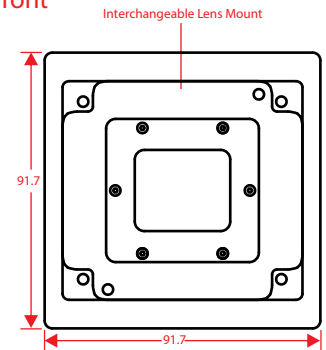

Top

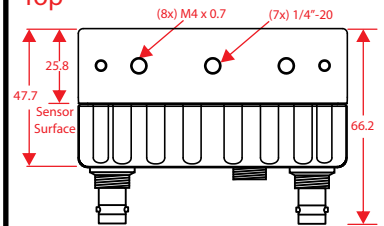

Rear

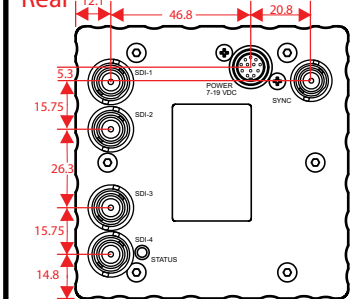

ACCESSORIES

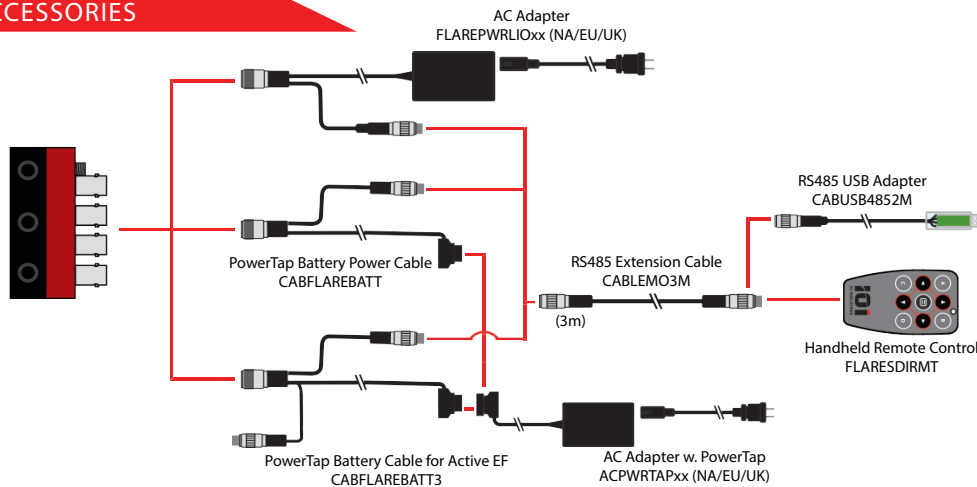

Visit us at: www.ioindustries.com
 15940 Robin's Hill Road
 London, Ontario, Canada, N5V 0A4
 Tel: +1 519 663 9570
 Email: sales@ioindustries.com

LET'S STAY CONNECTED!



@IOINDUSTRIES



@IOINDUSTRIES



@IO-INDUSTRIES

Copyright © 2019 IO Industries Inc. Flare is a trademark of IO Industries. All other trademarks are the property of their respective owners.

Datasheet Rev. 3.1 (08/22/2019)
 Specifications subject to change without notice